

Aspire locks with a keypad interface are operated by a 4-7 digit User Code or by an ADA compliant User Key. Manager Keys provide management access and external power. Programming is accomplished via a Programming Key unique to the lock system. An optional mobile application tool simplifies lock system management and provides audit trail.

Lock Parts

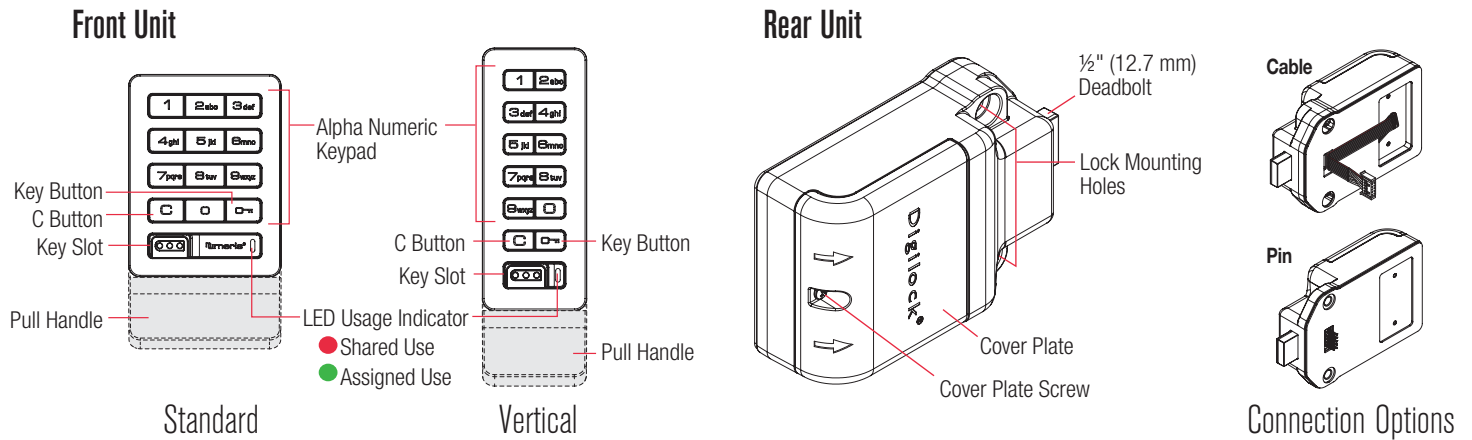

Keys



	User Key	Manager Key ¹	Programming Key ²
Operates the lock	•	•	•
Overrides user access		•	•
Allows management inspection		•	•
Provides external power		•	•
Programs Manager Keys to the lock			•
Assigns user credentials ³ (in assigned use functionality)		•	
Sets lock functionality			•

¹ Up to 6 Manager Keys may be programmed to each lock. If managed with the optional Mobile App, up to 250 Manager Keys may be programmed to each lock.

² 1 Programming Key allowed per lock system.

³ Up to 20 user credentials may be assigned to each lock. If managed with the optional Mobile App, up to 250 user credentials may be assigned to each lock.

Key Insertion

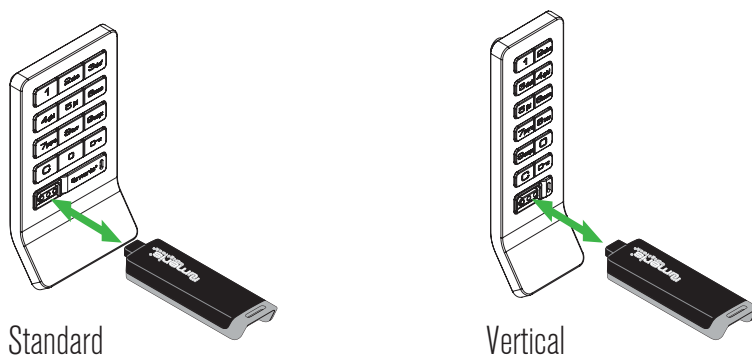

Numeris logo must face up on standard and vertical body locks.

Setup

Locks are shipped with factory default settings (only operates by pressing **[C]** **[0π]**). Each lock must be setup to operate with a Programming Key and Manager Keys.

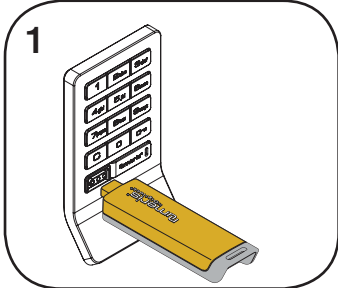

1
Insert the Programming Key.
A two-tone beep will be heard and the LED will turn on.

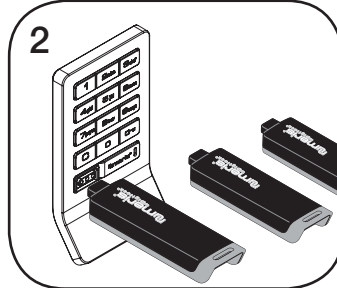

2
Insert one Manager Key at a time.
A beep will be heard for each Manager Key programmed.

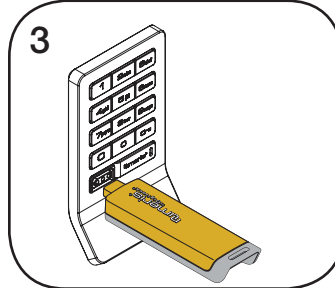

3
Insert the Programming Key.
A two-tone beep will be heard and the LED will turn off.

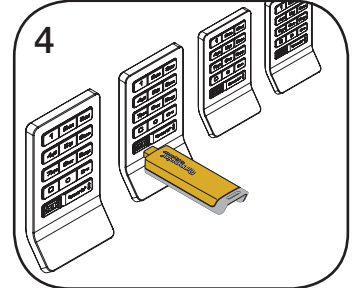

4
Repeat above steps for each lock or follow instructions to Express Register Manager Keys to setup all locks.

Programming Instructions

Express Register Manager Keys

The Programming Key can quickly program multiple locks to operate with the same Manager Keys.

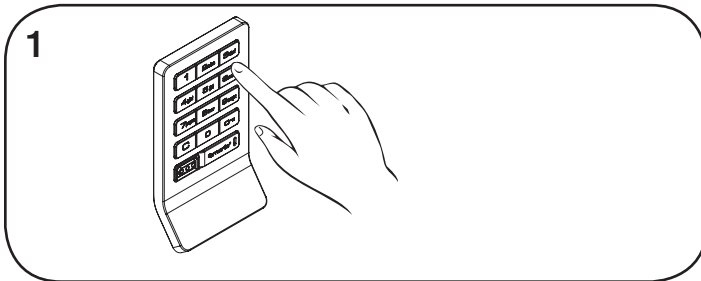

1
Go to a lock already programmed to operate with the Manager Keys.
Press **[C]** **[0π]** **[6]** **[1]** **[0π]**.
The LED will turn on.

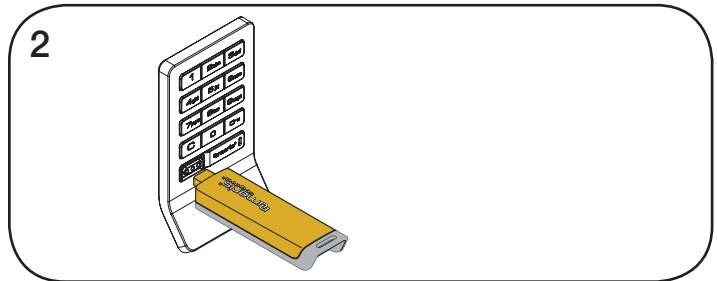

2
Insert the Programming Key.
A two-tone beep will be heard and the LED will turn off.

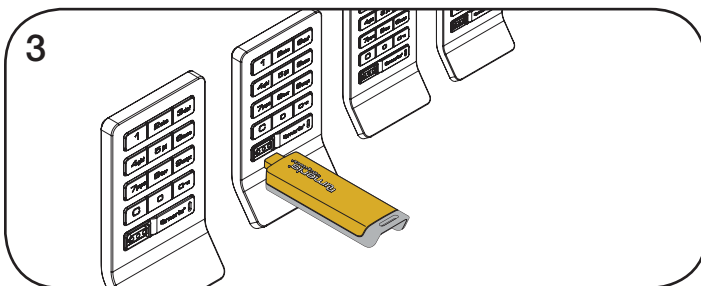

3
Insert the Programming Key to program each lock to operate with the same Manager Keys.
Two sets of two-tone beeps will be heard and the LED will flash twice to indicate successful programming.

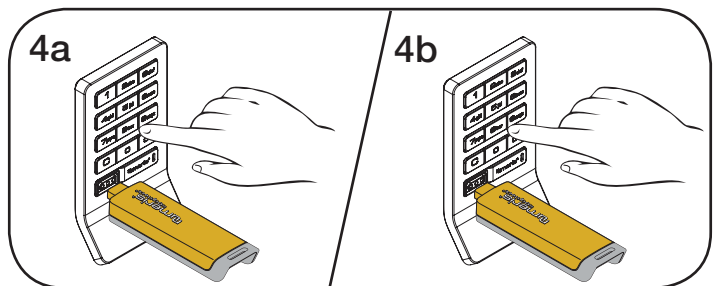

4a
End express registration mode.*
Go to any programmed lock.
Press **[C]** **[0π]** then insert the Programming Key.
4b
Press **[C]** **[0π]** then insert the Programming Key again to return the bolt to the original position.

*The Programming Key will continue to function in express registration mode until it is used to operate a lock.

Programming Instructions

Add Manager Keys

Manager Keys can be programmed to the locks at any time.

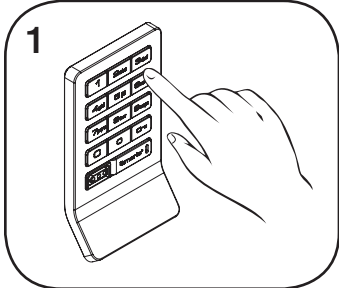

Go to a lock requiring additional Manager Keys.

Press **C** **0π** **5** **5** **0π**.

The LED will turn on.

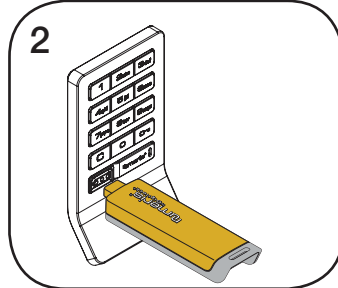

Insert the Programming Key.
A two-tone beep will be heard.

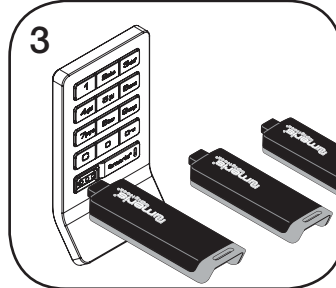

Insert each additional Manager Key one at a time.

A beep will be heard for each Manager Key programmed.

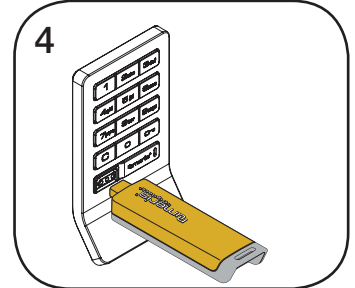

Insert the Programming Key.
A two-tone beep will be heard and the LED will turn off.

Repeat above steps for each lock or follow instructions to [Express Register Manager Keys](#) to quickly program multiple locks to operate with the same Manager Keys.

Replace Keys

The locks must be reprogrammed to prevent the lost/stolen keys from operating a lock.

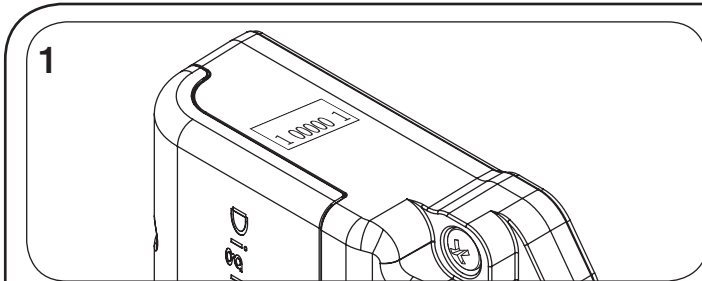

To replace the Programming Key:

Note the order or serial number (found on the lock's rear unit).



Contact Digilock Support to purchase a replacement Programming Key.

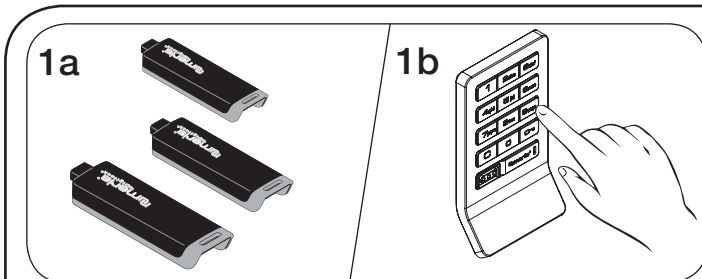

To replace the Manager Keys:

Collect all remaining and replacement Manager Keys.
Go to any lock operated by the lost/stolen Manager Keys.
Press **C** **0π** **5** **5** **0π**.
The LED will turn on.

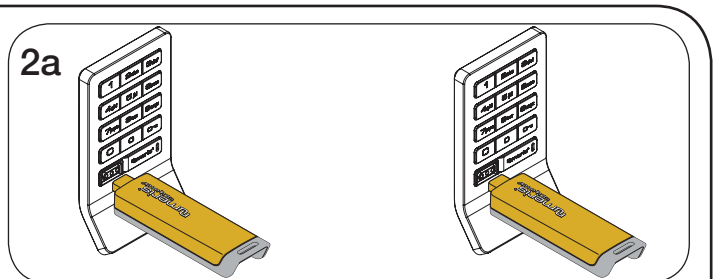

Insert the Programming Key.
A two-tone beep will be heard.
Insert the Programming Key again.
Three sets of two-tone beeps will be heard and the LED will turn off. All previously programmed Manager Keys will be erased.
Follow instructions to Add Manager Keys to program the remaining and replacement Manager Keys to the locks.

Programming Instructions

Set Lock Functionality

Each lock can be set for either shared or assigned use functionality. Press **[C]** to check functionality. If in shared use, LED is red. If in assigned use, LED is green.

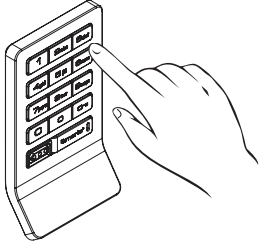
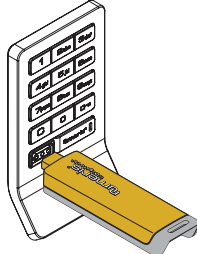
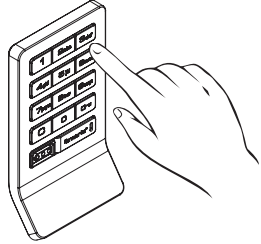
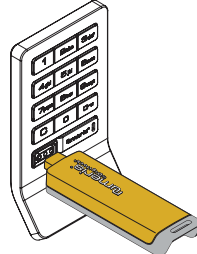
<p>1</p>  <p>To set for assigned use: Press [C] [0] [6] [5] [0]. The red LED will turn on.</p>	<p>2</p>  <p>Insert the Programming Key. A two-tone beep will be heard and the green LED will flash once.</p>	<p>1</p>  <p>To set for shared use: Press [C] [0] [5] [6] [0]. The green LED will turn on.</p>	<p>2</p>  <p>Insert the Programming Key. A two-tone beep will be heard and the red LED will flash once.</p>
---	---	--	---

Assign User Credentials (for assigned use functionality only)

Make sure that the lock is set for assigned use functionality (a green LED will flash when **[C]** is pressed). Up to 20 user credentials (User Codes and/or User Keys) may be assigned to each lock.

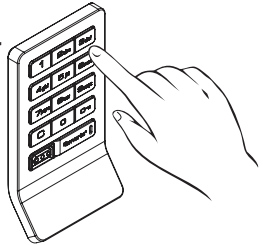
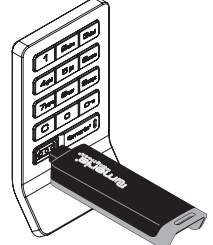
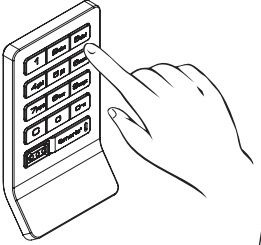
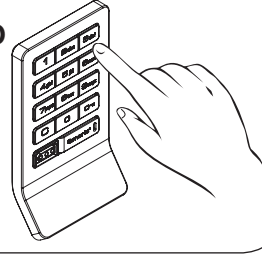
<p>1a</p>  <p>Assign User Codes: Press [C] [0] [5] [5] [0]. The LED will turn on. Insert a valid Manager Key. A two-tone beep will be heard.</p>	<p>1b</p> 	<p>2a</p>  <p>Press [C] [a new 4-7 digit code] [0]. A two-tone beep will be heard. Press [C] [the same 4-7 digit code] [0]. Two sets of two-tone beeps will be heard and the LED will turn off.</p>	<p>2b</p> 
--	--	--	--

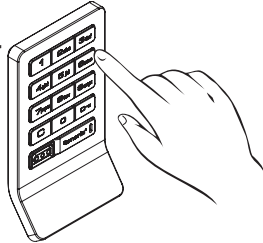
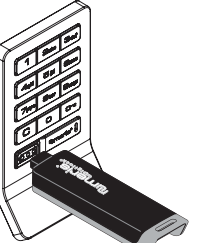
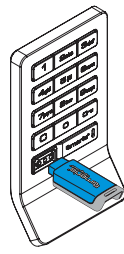
<p>1a</p>  <p>Assign User Keys: Press [C] [0] [5] [5] [0]. The LED will turn on. Insert a valid Manager Key. A two-tone beep will be heard.</p>	<p>1b</p> 	<p>2</p>  <p>Insert a User Key. Two sets of two-tone beeps will be heard and the LED will turn off.</p>
---	--	--

Programming Instructions - In Assigned Use Functionality

Express Register User Credentials and Manager Keys

Make sure the lock is set for assigned use functionality (a green LED will flash when **[C]** is pressed). The Programming Key can quickly program multiple locks to operate with the same user credentials and Manager Keys.

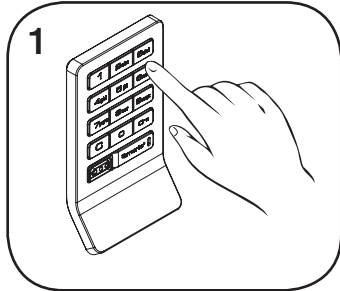

Go to a lock already programmed to operate with the user credentials and Manager Keys.

Press **[C]** **[0π]** **[6]** **[6]** **[0π]**. The LED will turn on.

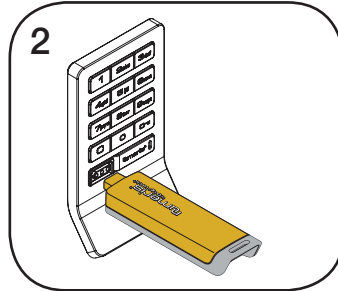

Insert the Programming Key.
A two-tone beep will be heard and the LED will turn off.

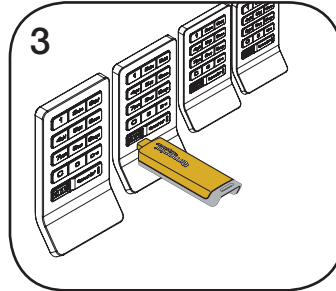

Insert the Programming Key to program each lock to operate with the same user credentials and Manager Keys.
Two sets of two-tone beeps will be heard and the LED will flash twice to indicate successful programming.

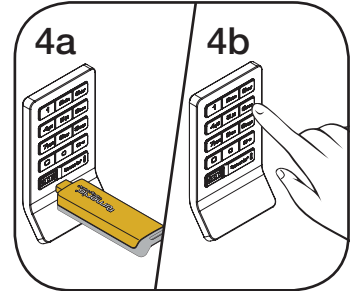

End express registration mode.*
Go to any programmed lock.
Press **[C]** **[0π]** then insert the Programming Key.
Press **[C]** **[0π]** then insert the Programming Key again to return the bolt to the original position.

*The Programming Key will continue to function in express registration mode until it is used to operate a lock.

Remove User Credentials

Make sure the lock is in assigned use functionality (a green LED will flash when **[C]** is pressed). The locks must be reprogrammed to remove user credentials from operating a lock.

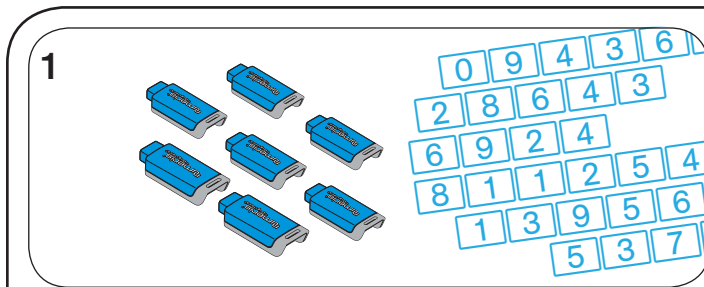

Collect all remaining and replacement user credentials (User Codes and User Keys).

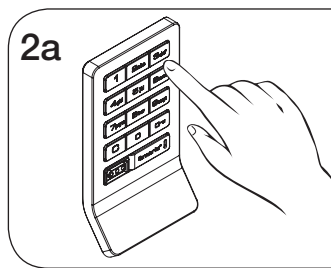

Press **[C]** **[0π]** **[5]** **[5]** **[0π]**.
The LED will turn on.
Insert a valid Manager Key.
A two-tone beep will be heard.

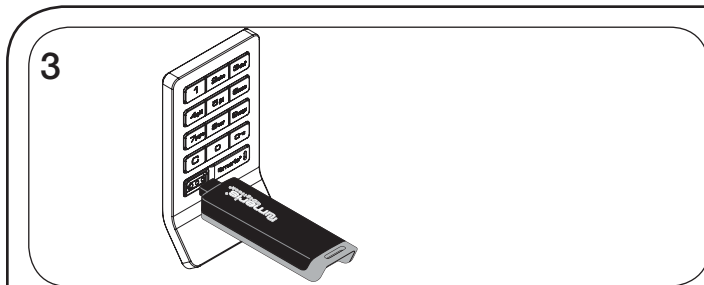
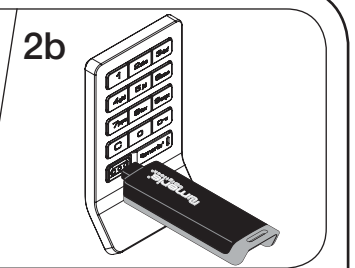

Insert the Manager Key again.
Three sets of two-tone beeps will be heard and the LED will turn off. All previously assigned user credentials will be removed.

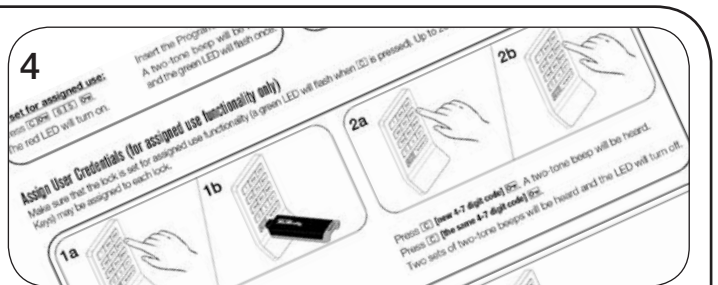

Follow Assign User Credentials instructions to assign the remaining and replacement user credentials to the locks.

Programming Instructions - In Assigned Use Functionality

Replace a User Credential

1

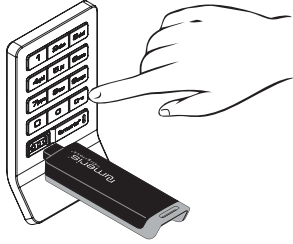

Replace an Assigned User Code with a New User Code:

Press **[C]** **[0π]** then insert a valid Manager Key.

A two-tone beep will be heard and the LED will turn on.

2

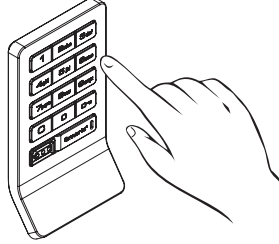

Press **[C]** **[assigned user code]** **[0π]**.

A two-tone beep will be heard.

3

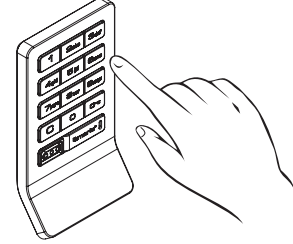

Press **[C]** **[a new 4-7 digit user code]** **[0π]**
[C] **[the same 4-7 digit user code]** **[0π]**.

Two sets of two-tone beeps will be heard and the LED will turn off.

1

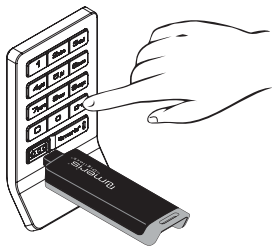

Replace an Assigned User Code with a New User Key:

Press **[C]** **[0π]** then insert a valid Manager Key.

A two-tone beep will be heard and the LED will turn on.

2

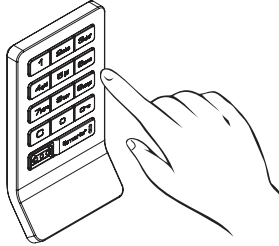

Press **[C]** **[assigned user code]** **[0π]**.

A two-tone beep will be heard.

3

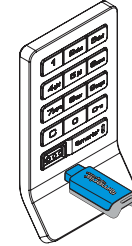

Insert a new User Key.

Two sets of two-tone beeps will be heard and the LED will turn off.

Programming Instructions - In Assigned Use Functionality

Replace a User Credential

1

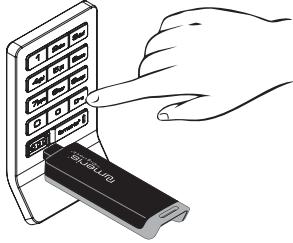

Replace an Assigned User Key with a New User Key:

Press **C** **0π** then insert a valid Manager Key.
A two-tone beep will be heard and the LED will turn on.

2

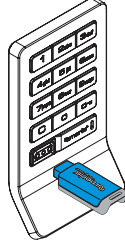

Insert the assigned user Key.
A two-tone beep will be heard.

3

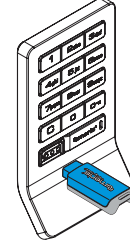

Insert a new User Key.
Two sets of two-tone beeps will be heard and the LED will turn off.

1

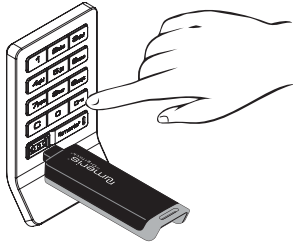

Replace an Assigned User Key with a New User Code:

Press **C** **0π** then insert a valid Manager Key.
A two-tone beep will be heard and the LED will turn on.

2

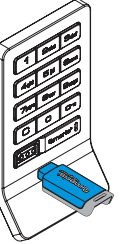

Insert the assigned User Key.
A two-tone beep will be heard.

3

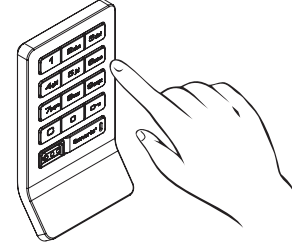

Press **C** **[new 4-7 digit user code]** **0π**
C **[the same 4-7 digit user code]** **0π**.
Two sets of two-tone beeps will be heard and the LED will turn off.

Set Additional Lock Features (for shared use functionality only)

LED Usage Indicator

When in shared use functionality, each lock can be programmed to have the LED flash or not flash while the lock is in use. The default setting is ON (red LED flashes while lock is in use).

<p>To turn off the LED Usage Indicator: Press C 0 9 2 0.</p> <p>The LED will flash.</p>	<p>Insert the Programming Key. A two-tone beep will be heard and the LED will turn off.</p>	<p>To turn on the LED Usage Indicator: Press C 0 9 1 0.</p> <p>The LED will flash.</p>	<p>Insert the Programming Key. A two-tone beep will be heard and the LED will turn off.</p>

Auto Unlock

When in shared use functionality, each lock can be programmed to auto unlock after a set number of hours. The default setting is OFF (does not auto unlock).

<p>To turn on Auto Unlock: Press C 0 9 5 0.</p> <p>The LED will flash. Insert the Programming Key. A two-tone beep will be heard and the LED will turn on.</p>		<p>Enter the number of hours from 1 - 9 9 then press 0.</p> <p>Two sets of two-tone beeps will be heard and the LED will turn off. For example: Press 8 0 to set the lock to auto unlock after 8 hours.</p>

<p>To turn off Auto Unlock: Press C 0 9 4 0.</p> <p>The LED will flash.</p>	<p>Insert the Programming Key. A two-tone beep will be heard and the LED will turn off.</p>

Operating Instructions - In Shared Use Functionality

In shared use functionality, the user enters any 4-7 digit User Code or inserts any User Key to lock and the same User Code or User Key to unlock. Once unlocked, the lock is available for a different user.

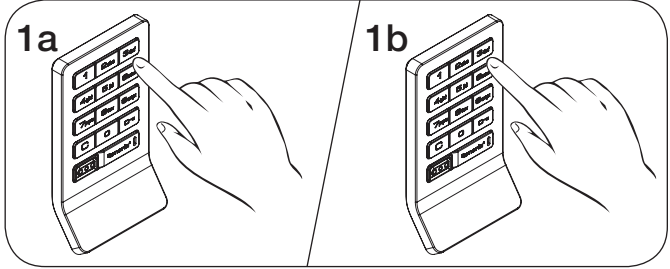

1a **1b**

Operate with a User Code
To lock: Press [C] [any 4-7 digit code] [C].
To unlock: Press [C] [the same 4-7 digit code] [C].*

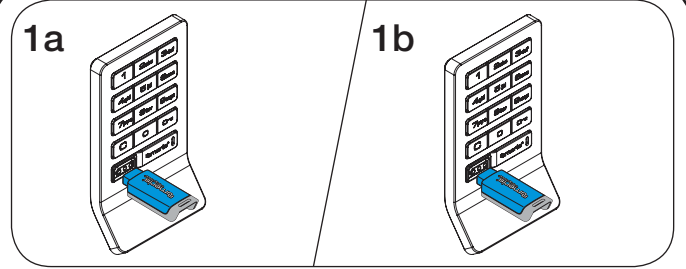

1a **1b**

Operate with a User Key
To lock: Insert any User Key.
To unlock: Insert the same User Key.

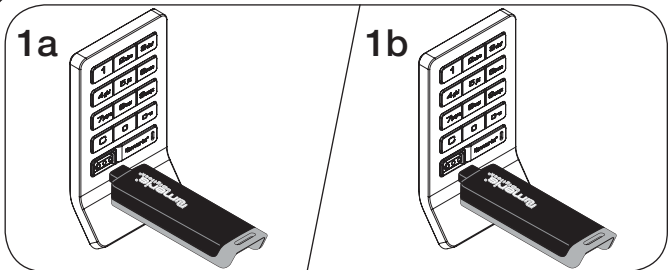

1a **1b**

Operate with a Manager Key
To unlock: Insert a valid Manager Key.
To relock: Insert a valid Manager Key.**

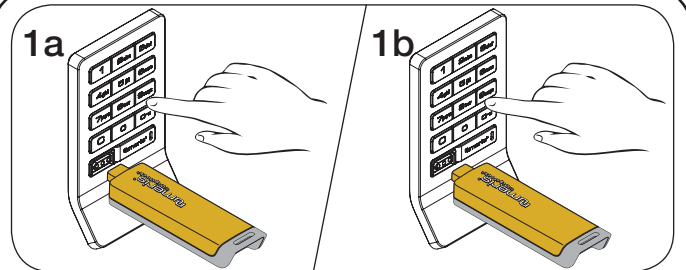

1a **1b**

Operate with the Programming Key
To unlock: Press [C] [C] then insert the Programming Key.
To relock: Press [C] [C] then insert the Programming Key.**

*After 3 consecutive incorrect user code entries, the keypad will be disabled for 1 minute (Sleep Mode).

**If a valid Manager Key or the Programming Key is used to relock, the previous user credential will continue to operate the lock.

Operating Instructions - In Assigned Use Functionality

In assigned use functionality, users operate the lock with their assigned user credential (either a User Code or a User Key).

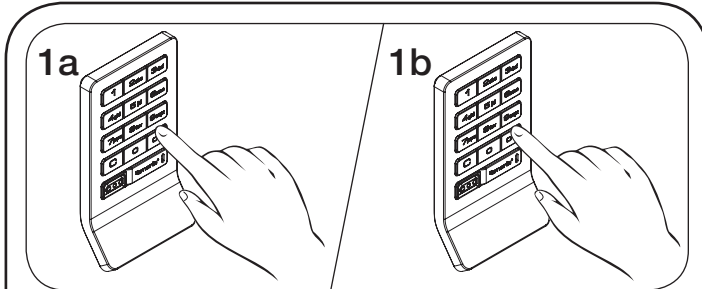

Operate with a User Code

To unlock: Press **C** [assigned 4-7 digit code] **0M**.*

To relock: Press **C** [assigned 4-7 digit code] **0M** or press **C** **0M** **0M**.

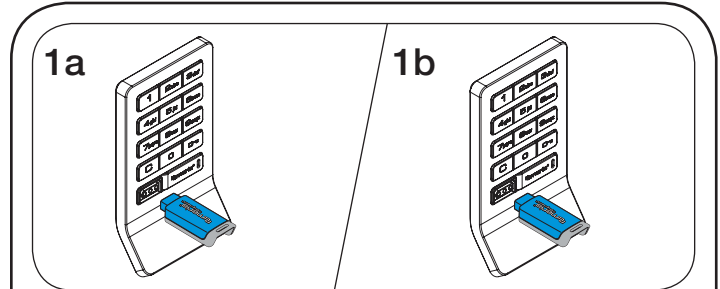

Operate with a User Key

To unlock: Insert the assigned User Key.

To relock: Insert the assigned User Key or press **C** **0M** **0M**.

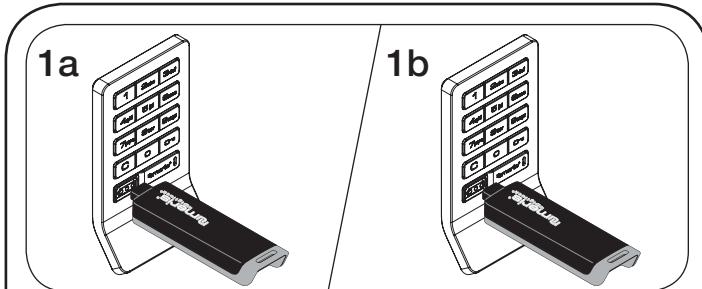

Operate with a Manager Key

To unlock: Insert a valid Manager Key.

To relock: Insert a valid Manager Key or press **C** **0M** **0M**.

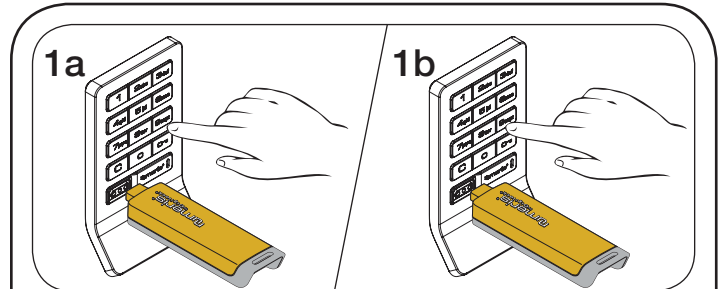

Operate with the Programming Key

To unlock: Press **C** **0M** then insert the Programming Key.

To relock: Press **C** **0M** then insert the Programming Key or press **C** **0M** **0M**.

*After 3 consecutive incorrect user code entries, the keypad will be disabled for 1 minute (Sleep Mode).

Support

Sleep Mode

After three consecutive incorrect User Code entries to unlock, the lock will go into “Sleep Mode” for one minute and for an additional minute for each subsequent incorrect entry. The keypad is disabled while in “Sleep Mode”. A valid Manager Key may be used to unlock while the lock is in “Sleep Mode”.

Error Condition Indicators

10 rapid beeps:

The lock is binding which means that either door alignment or stored items are preventing the lock from operating. Press on the door while operating the lock. If error condition persists, contact Digilock support for assistance.

2 sets of three beeps:

The batteries are low. Replace the batteries.

Does not Unlock with the User Code or User Key

The lock does not recognize the User Code or User Key. For immediate access, operate with a valid Manager Key. If in assigned use functionality, follow instructions to [Assign the User Credentials](#) to assign user credential to the lock.

Does not Operate with a Manager Key

The lock does not recognize the Manager Key. Follow instructions to [Add Manager Keys](#) to program the Manager Key to the lock. For immediate access, operate with another valid Manager Key or with the Programming Key.

Does not Operate with the Programming Key

The lock does not recognize the Programming Key. If the Programming Key has been replaced, operate with the Replacement Programming Key. Contact Digilock support for additional assistance.

No Audible Feedback when is Pressed

- The lock may be in “Sleep Mode” or the batteries may need to be replaced. For immediate access, operate with a valid Manager Key.
- The front unit may not be properly connected to the rear unit. Remove the lock from the door and check the connection.

Battery Replacement

It is not necessary to remove the lock from the door. In case of battery failure, operate with a valid Manager Key.

CAUTION: Risk of explosion or leakage if battery is replaced by an incorrect type, mixed with a different battery type, or inserted backwards. Replace all batteries of a set at the same time. Be sure to insert batteries with correct polarities. Remove exhausted batteries from product promptly and dispose of used batteries according to the battery manufacturer's instructions.

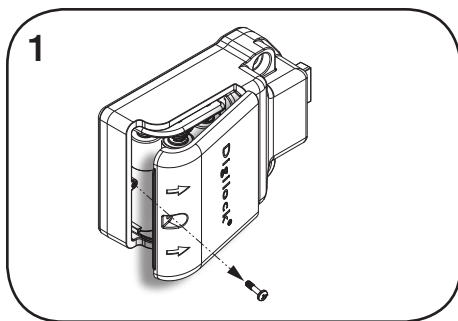

1 Remove the screw from the Cover Plate with a Phillips head screwdriver.

Remove the Cover Plate by lifting the tab at the edge of the cover, below the arrows.

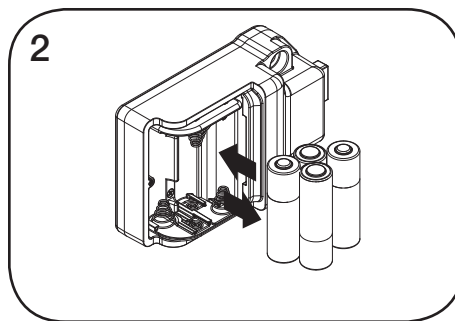

2 Remove the batteries from the housing.

Replace with four premium alkaline AA batteries. Dispose or recycle used batteries according to local regulations.

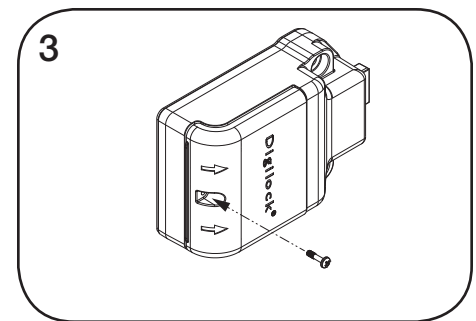

3 Replace the Cover Plate and secure with the screw.